

CORE / BRIDGE

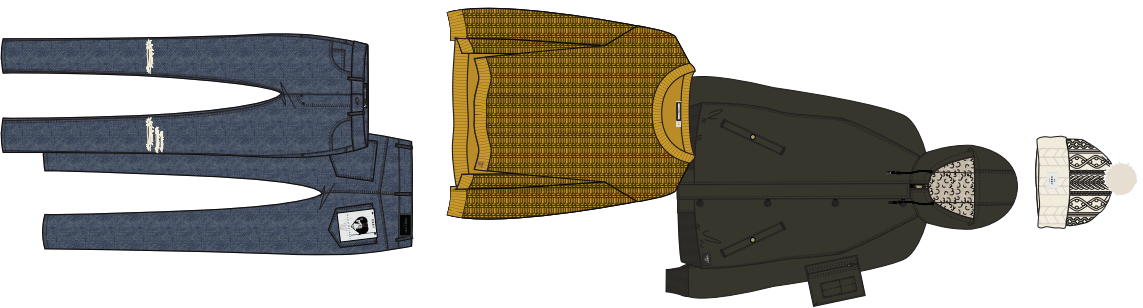

"OVERSIZED / RETURN OF DENIM"



"OVERSIZED"

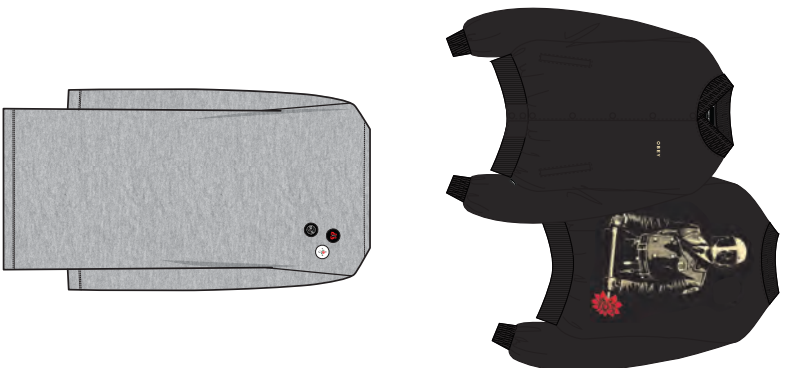

"BOMBER / SOFT KNIT DRESSING"

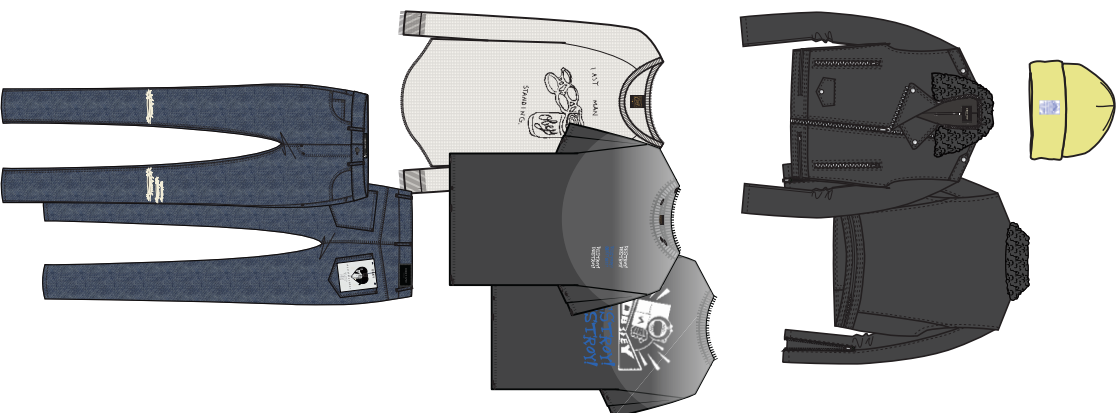

"OVERT MESSAGE / RETURN OF DENIM"

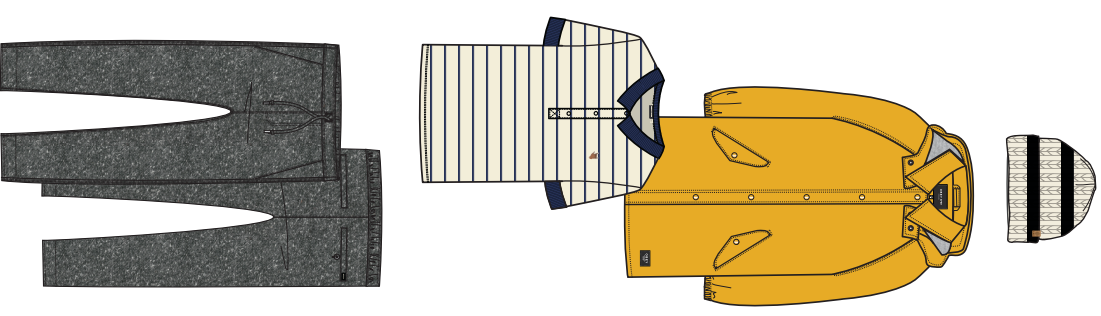

"SOFT KNIT DRESSING"

DIRECTIONAL / STATEMENT

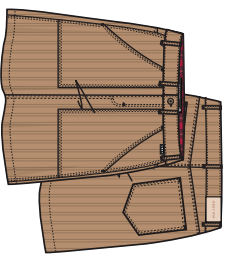
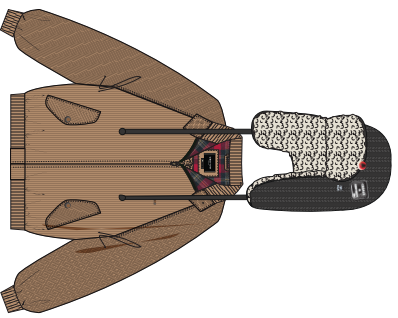

"OVERT MESSAGE"

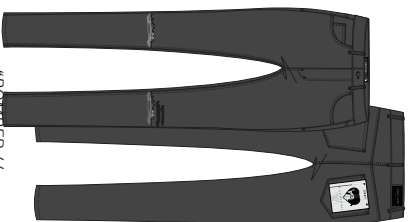
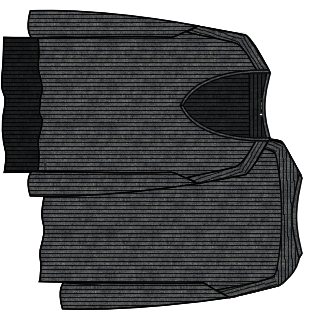
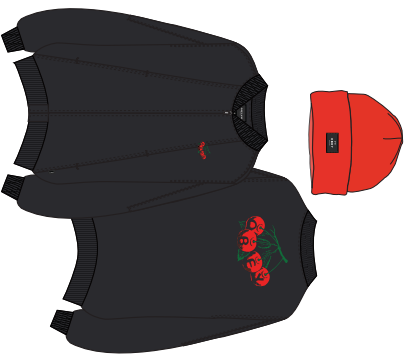

"BOMBER // RETURN OF DENIM"

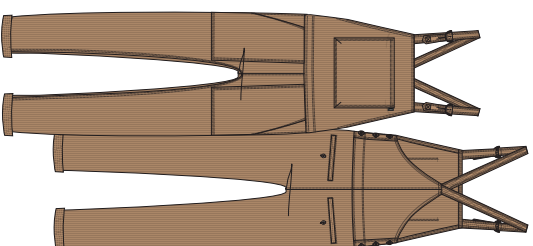
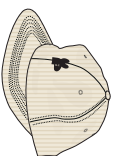

"OVERT MESSAGE"

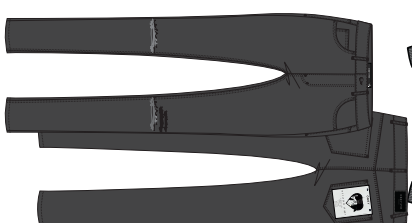
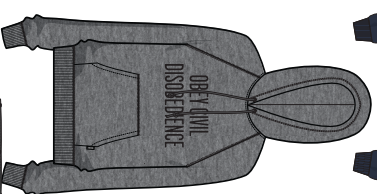
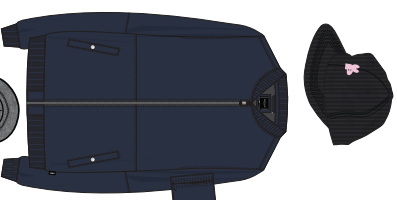

"OVERSIZED // RETURN OF DENIM"

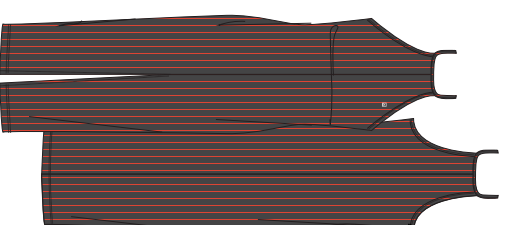
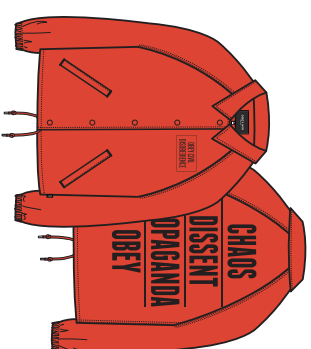

"OVERT MESSAGE // SOFT KNIT DRESSING"

ASPIRATIONAL

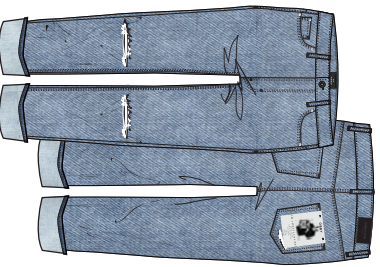
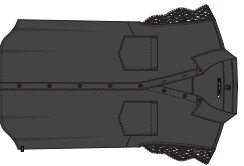
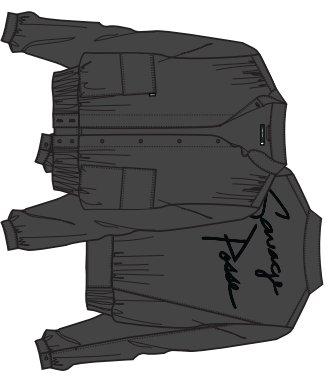

"SUNDAY ST. LEG DENIM"

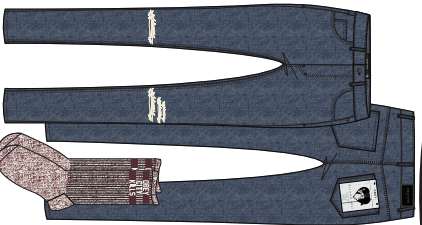
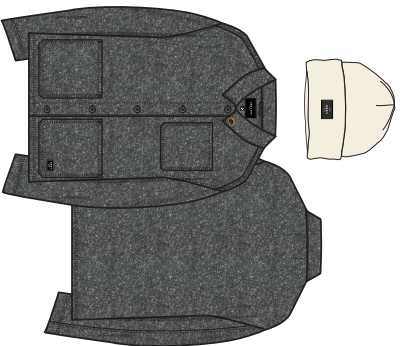

"SOFT KNIT DRESSING//
RETURN OF DENIM"

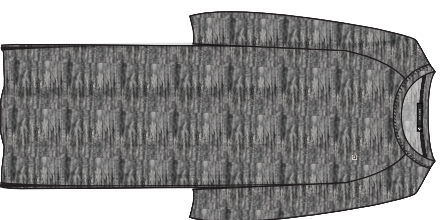
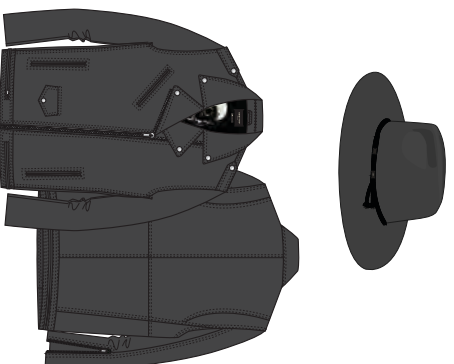

"OVERSIZED OUTERWEAR//
SOFT KNIT DRESSING"

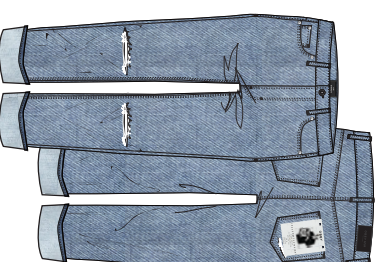
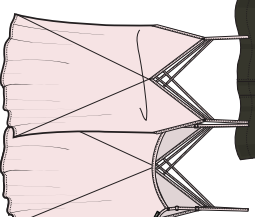
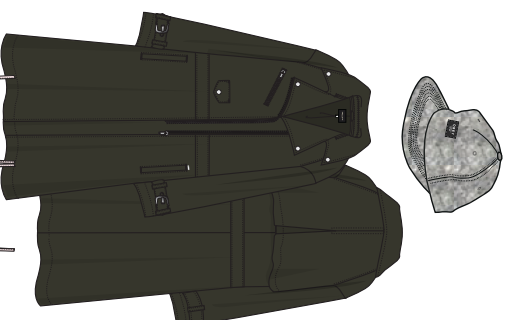

"OVERSIZED OUTERWEAR//
RETURN OF DENIM"

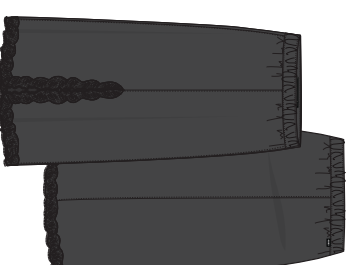
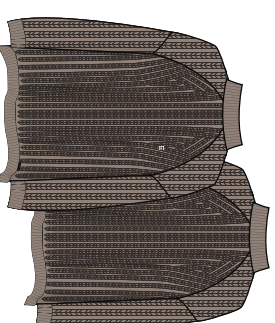

"BOMBER JACKETS//
OVER MESSAGING"